

Effect of Alkaline Copper Quaternary Type D on Color Retention, Mold Resistance, and Surface Physicochemical Characterization of *Neosinocalamus affinis* Bamboo

Lu He Lin Chen Jiulong Xie Jinqiu Qi Yongze Jiang
Hui Xiao Yuzhu Chen Xingyan Huang Lihua Tu
Todd Shupe

Abstract

The effect of alkaline copper quaternary type D (ACQ-D) treatment on color retention, mold resistance, and surface physicochemical characterization of *Neosinocalamus affinis* bamboo was analyzed. The results showed that a treatment of 0.25 percent ACQ-D solution combined with pretreatment of potassium hydroxide and sodium dodecyl sulfate mixed aqueous solution can achieve a desired green color on the bamboo surface. The mold test result revealed that the treated bamboo samples had better mold resistance than samples only treated with a mold inhibitor. The thermogravimetric–Fourier-transform infrared spectroscopy analysis of the treated and the control samples indicated that the chemical structure of the surface was slightly modified, e.g., silicon was almost completely removed, which enhanced liquid permeability. The dilute ACQ-D solution combined with a proper pretreatment process could retain the favorable green color of bamboo and also improve mold resistance by slightly modifying the surface chemistry.

Neosinocalamus affinis grows widely in southwest China (Cattaneo et al. 2005), especially in Sichuan Province (the geographical distribution, cultivation, and utilization center of *N. affinis*; Wang et al. 2009), where *N. affinis* has been widely cultivated and used in furniture (Zhang et al. 2013), construction (Scurlock 2000, Oyedun et al. 2013), and interior decoration products (Chele et al. 2012). One of the key traits that is highly favored in bamboo is its green color. However, the color fades in service due to ultraviolet (UV) degradation of the surface (Wenhua 2006, Wang and Ren 2008), resulting in reduction in product aesthetics and economic value.

Previous researchers have used chromatec copper arsenate to treat *Phyllostachys makino* bamboo timber (Chung et al. 2005). Although good effect on color retention was obtained, the process was not adopted due to environmental and health concerns (Chang and Wu 2000, Chang and Yeh 2001, Xu et al. 2013). Previous research also applied a mixed solution of CrO₃ and H₃PO₄ to treat *Dendrocalamus latiflorus* (Chang 2000, Chang and Wu 2001) and *Phyllostachys heterocycla* (Chang and Yeh 2001, Chang et al. 2002b), and explored the effect of changing the addition

order of CrO₃ and H₃PO₄ (Chang et al. 2002a). In order to avoid the use of chromium-based agents, Wu et al. (2002) treated *D. latiflorus* using a mixture of CuSO₄ and H₃PO₄. To simplify the treatment process and improve the efficiency, researchers also treated *D. latiflorus* and *P. makino* bamboo in alcohol-based CuCl₂, Cu(CH₃COO)₂, Cu(NO₃)₂ solvents (Wu et al. 2004; Chung et al. 2005, 2008). Alkaline copper quaternary (ACQ) has also been

The authors are, respectively, Postgraduate Student, Postgraduate Student, Associate Professor, Professor, Research Assistant, PhD Candidate, PhD Candidate, Associate Professor, and Professor, Dept. of Wood Sci. and Technol., College of Forestry, Sichuan Agric. Univ., Chengdu, China (HeLu53684@aliyun.com, chenlin2018@aliyun.com, jxie@sicau.edu.cn [corresponding author], qijingqiu2005@aliyun.com, 72076@sicau.edu.cn, xh_b70405@126.com, populus_zhu@163.com, hxysicau@edu.cn, tulhsicau@163.com); and President, Wood Sci. Consulting, LLC, Baton Rouge, Louisiana (todd@drtoddschupe.com). This paper was received for publication in December 2019. Article no. 19-00066.

©Forest Products Society 2020.
Forest Prod. J. 70(3):302–308.
doi:10.13073/FPJ-D-19-00066

used to treat bamboo for the retention of its natural green color. The potential of ACQ type B to maintain bamboo color has been evaluated using *D. latiflorus* and *Phyllostachys pubescens* (Chung et al. 2009). The results were favorable for color retention, but its effect on mold resistance was not evaluated. A mixture of H₃PO₄ and CuSO₄ has been successfully used to treat *N. affinis* to maintain the bamboo's green color (Chen et al. 2019). However, the mold resistance was not favorable. Therefore, ACQ type D (ACQ-D) solution was selected to treat *N. affinis* bamboo samples in this study. The purpose of this study is to evaluate the potential of ACQ-D solution for retention of the bamboo's green color and for mold resistance.

Materials and Methods

Materials

Three-year-old *N. affinis* bamboo samples were harvested near Chengdu, China. The samples were briefly stored without light at 4°C while the experimental equipment reached the required temperature. The mold inhibitor was commercially purchased from Jiansi Chemicals Co. Ltd. (Guangzhou, China) and consisted of a variety of organic emulsified fungicides and self-assembled polymers. All chemicals were commercially purchased and used as received.

Methods

Treatment process.—Samples were pretreated to nominal dimensions of 50 mm (length) by 40 mm (width) by bamboo thickness. Prior to the ACQ-D treatment, four different pretreatment methods were used to remove the wax layer and inorganic substances (Table 1). The pretreatment process was aimed at increasing the surface moisture content and decreasing the contact angle, which could increase the reaction between the treatment agent and the surface (Chang 2000). After the pretreatment process, the samples were placed in solutions of ACQ-D with serial concentrations of 0.25, 0.5, 1.0, 1.5, and 2.0 percent. The treatments were maintained at 100°C for different times (1 h, 2 h). Thereafter, the treated samples were dried in an oven at 60°C for 12 hours. The moisture content of the sample after drying was 8.39 percent.

Color measurement.—Color parameters of the bamboo surfaces were collected using a high-quality computer colorimeter (NR69CP, Shenzhen Threneh Technology Co., Ltd., Shenzhen, China) with a D65 light source and a measuring aperture of 3 mm. Thirty locations per sample were randomly selected for measurement. According to the Commission Internationale d'Éclairage (CIE) LAB color system (Chang and Yeh 2001), L* is the value on the white/black axis, a* is the value on the red/green axis, and b* is

the value on the blue/yellow axis. Since the value of a* indicates the change of red to green, a low value of a* represents good green color protection.

Green color retention test.—The outdoor green color retention test was carried out on the campus of Sichuan Agricultural University, Chengdu, from June 20, 2018, to July 7, 2018. In order to enhance UV light exposure, the test samples were placed on a wooden board at an approximate angle of 30° facing south. The outer sides of the samples were facing upward. The test lasted for 18 days. The average rainfall precipitation, temperature, and pH were 346.65 mm, 25°C, and 7.48, respectively. Meanwhile, samples were also prepared for the indoor green color retention test. The indoor retention test lasted for 130 days, from June 20, 2018, to October 27, 2018.

Mold resistance.—For the mold resistance experiment, the fresh bamboo and color-preserved bamboo samples were both treated with a mold inhibitor under the same conditions. The samples were immersed in the 2 percent mold-inhibitor solution for 1 hour at 25°C. The mold resistance experiment was conducted in accordance with ASTM D4445-2010 (ASTM International 2015) with minor modification. For the test, samples with dimensions of 50 mm (length) by 20 mm (width) by bamboo thickness were prepared for the mold-inhibitor-treated bamboo and untreated fresh bamboo (control). Thereafter, the samples were irradiated under UV light for 30 minutes. Potato dextrose agar culture medium was prepared and poured into the petri dish. After high-temperature and high-pressure sterilization treatment, *Trichoderma harzianum* was inoculated and cultured at a constant temperature and humidity incubator for 3 to 4 days. The prepared samples were placed in the above inoculated medium as shown in Figure 1. The experiment was conducted in an incubator at 25°C ± 1°C and 70 to 80 percent relative humidity for 3 weeks, and the mold infestation area was recorded every 2 days. The specific calculation formula for the infecting ratio is as follows:

$$\text{Infecting ratio(\%)} = (\text{infected area}/\text{area of sample}) \times 100\%$$

Thermogravimetric–Fourier-transform infrared spectroscopy analysis.—The thermogravimetric–Fourier-transform infrared spectroscopy (TG-FTIR) analysis was performed with a NETZSCH STA 409 PC/PG. Approximately 20 mg each of the untreated and treated samples were used in each test. The samples treated by Pretreatment III (i.e., with 0.7% KOH and 0.7% sodium dodecyl sulfate [SDS]; Table 1) for 30 minutes were designated as P, and the samples treated by Pretreatment III followed by 0.25 percent ACQ-D at 100°C for 2 hours were designated as P + A. Pure nitrogen was injected as a protective gas at a rate of 60 mL/min, and the temperature was raised from room temperature to 800°C at a heating rate of 10°C/min. The spectral region and resolution

Table 1.—Pretreatment methods and chemical formulae.

Pretreatment	Composition	Ratio	Concentration (%)	Temperature (°C)
Control	—	—	—	—
I	KOH, SDS ^a	2:3	5	80
II	K ₂ CO ₃ , SDS	4:1	5	80
III	KOH, SDS	0.7:0.7	1.40	100
IV	KOH	1	1	80

^a SDS = sodium dodecyl sulfate.

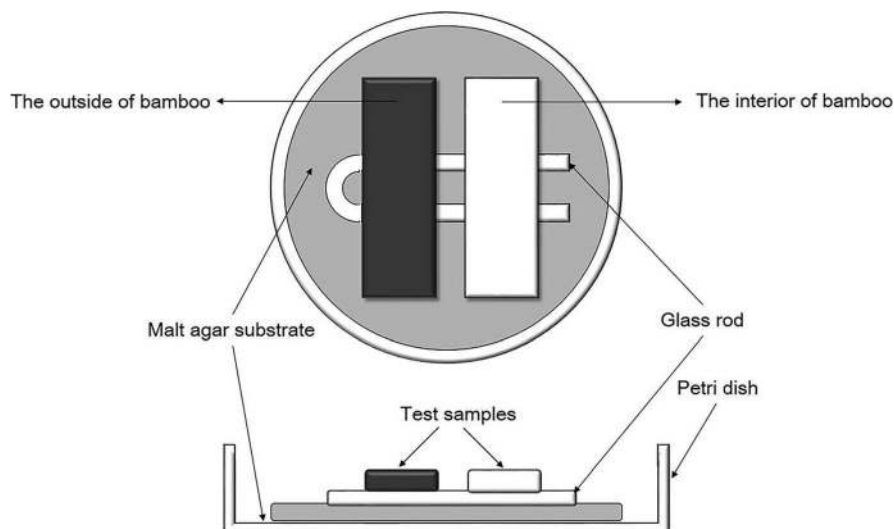

Figure 1.—Placement of samples in antimold experiment.

of the FTIR were 4,000 to 400 and 4 cm^{-1} , respectively, and the spectrum scan was conducted with three intervals.

Results and Discussion

Green color retention evaluation

The a^* values of *N. affinis* bamboo samples under different pretreatment methods followed by ACQ-D treatment are presented in Figure 2. For comparison, the a^* values for the samples pretreated with the Pretreatment III (0.7% KOH and 0.7% SDS) were the lowest when the concentration of the ACQ-D was 0.25 percent.

Figure 3 shows the effect of treatment time of ACQ-D solution on the $L^*a^*b^*$ (LAB) value of *N. affinis* samples under different pretreatments. The a^* values of the samples treated for 2 hours were lower than those treated for 1 hour with the exception of Pretreatment IV. It could be concluded that prolonging the treatment time had a positive effect on the retention of the green color. However, the differences

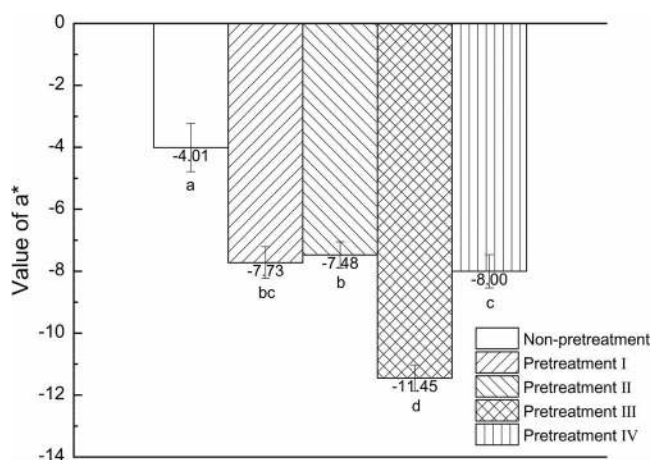

Figure 2.—Changes in a^* values of *Neosinocalamus affinis* after using different pretreatment methods; lowercase letters mean significant differences (at the 0.05 level) of a^* value after using different pretreatment methods.

induced by the treatment time were not obvious and further research is needed.

Figure 4 shows the LAB value of *N. affinis* bamboo samples with respect to the concentration of ACQ-D. The results showed that samples treated with 0.25 percent ACQ-D solution had the lowest a^* value: -11.45 . The a^* values of *N. affinis* samples increased with increasing ACQ-D concentration. This result indicated that the increase in the concentration would decrease the bamboo color retention.

Green color retention test

Figure 5 shows the changes in the a^* values of *N. affinis* samples from different treatment methods with respect to duration of outdoor exposure. The a^* values of the four group samples gradually increased by extending the exposure time. After 4 days, the a^* values of the untreated

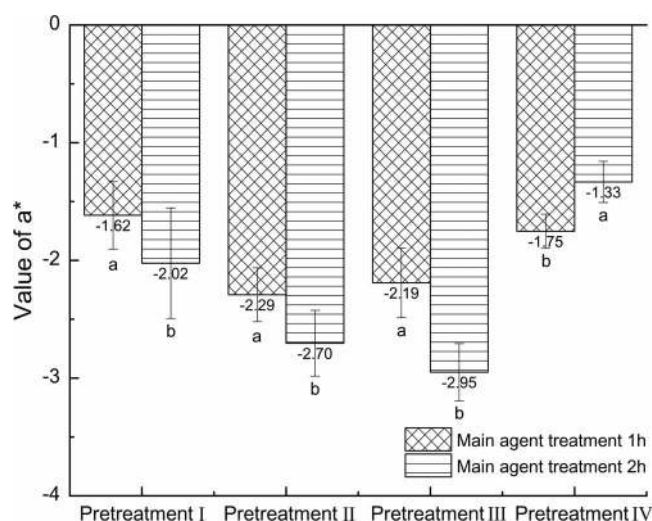

Figure 3.—Changes in a^* values of *Neosinocalamus affinis* with different alkaline copper quaternary type D (ACQ-D) solution treatment times; lowercase letters mean significant differences (at the 0.05 level) of a^* value with different ACQ-D solution treatment times.

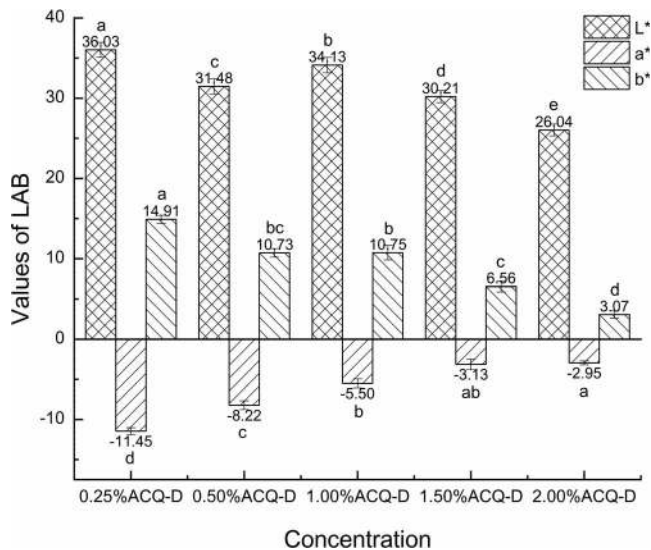

Figure 4.—Effect of alkaline copper quaternary type D (ACQ-D) concentration on the color parameters of *Neosinocalamus affinis* bamboo; lowercase letters mean significant differences (at the 0.05 level) of L^* a^* b^* values with different ACQ-D concentrations.

N. affinis sample reached a positive value, while the a^* values of the treated *N. affinis* samples remained negative. The combination of pretreatment with 0.7 percent KOH and 0.7 percent SDS and the treatment of 0.25 percent ACQ-D solution resulted in the lowest a^* value and the smallest increment in the a^* value after the outdoor aging test. This finding indicates that a lower concentration of ACQ-D solution (0.25%) with a proper pretreatment process (0.7% KOH and 0.7% SDS) was effective for color retention. Since the exposure test was in the rainy season in Sichuan, China, the a^* value for all the samples became positive after 3 weeks of outdoor exposure because of the large amount of precipitation during the exposure test. In order to avoid the effects of precipitation and direct sunlight, we also conducted an indoor exposure test.

Figure 6 shows the changes in the a^* values of *N. affinis* samples after treatment with Pretreatment III + 0.25 percent ACQ-D with respect to duration of indoor exposure. The a^* values changed from -11.20 to -5.56 . In the first 30 days, the a^* value showed minimal change and only increased by 0.41. With prolonging the test time, the a^* value began to slowly increase. After 130 days, the value still remained negative. This result indicated that the a^* values of the samples treated with Pretreatment III + 0.25 percent ACQ-D had negligible changes in the indoor environment, which showed better color retention ability.

Antimold ability analysis

Figure 7 shows the infecting ratios of the control, mold-inhibitor sample, and preserved-green-color sample of *N. affinis* bamboo. It can be seen that the infecting ratio of *T. harzianum* on the outer surface of the control reached 100 percent in 4 days, while the values for the mold-inhibitor and mold-inhibitor plus color-preserved samples were 8 and 15 days, respectively. The mold resistance test of the inner surface of bamboo showed similar results to that of the outer surface, i.e., the infecting ratio for both the outer and inner

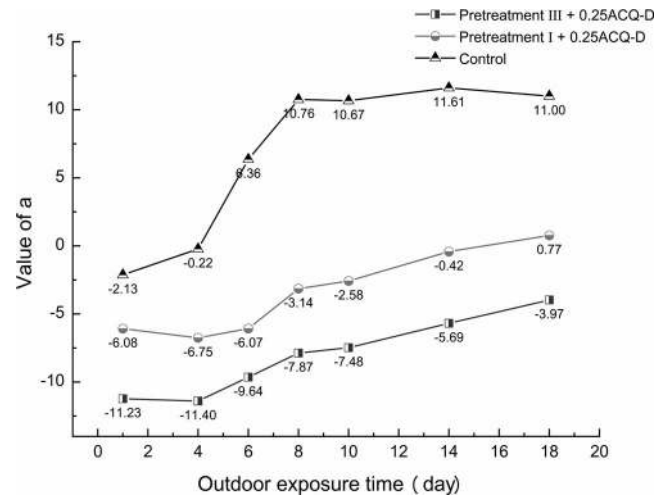

Figure 5.—Changes in a^* values of treated *Neosinocalamus affinis* bamboo samples with respect to outdoor exposure time. ACD-Q = alkaline copper quaternary type D.

samples treated by the mold inhibitor plus ACQ-D solution was the lowest. However, for comparison, the mold resistance on the inner surface was better than that of the outer surface. The bamboo samples treated with the mold inhibitor after the green-color treatment showed a better antimold effect than the control and the samples only treated by the mold inhibitor. This may be due to the removal of the wax layer and silicon on the bamboo surface during the color-protection treatment process; i.e., the silicon content for the control and the green-color-preserved bamboo samples was determined to be 14.44 and 1.04 percent, respectively, by energy-dispersing X-ray analysis with scanning electron microscopy (Chen et al. 2019). Therefore, the removal of the wax and siliceous materials improved the permeability of the bamboo and the accessibility of the mold-inhibiting agent into the bamboo cells, resulting in the improvement in the antimold ability.

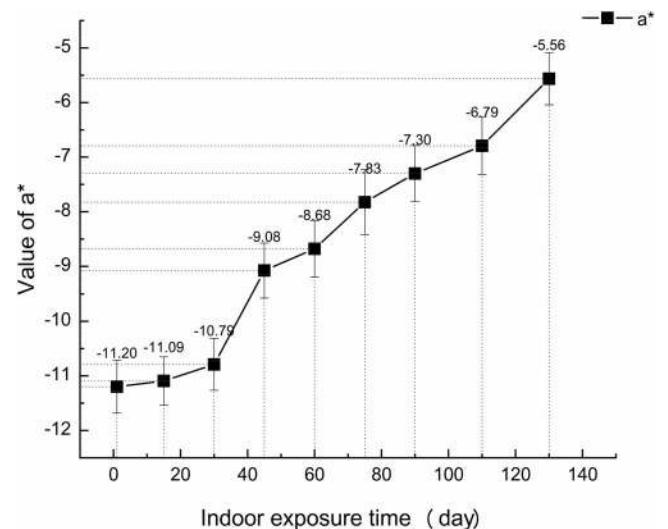

Figure 6.—Changes in a^* values of treated *Neosinocalamus affinis* bamboo samples with respect to indoor exposure time.

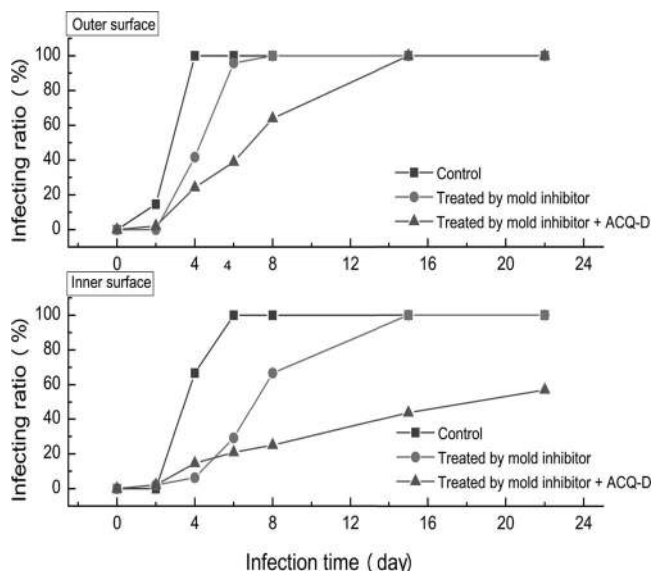

Figure 7.—Infecting ratio of the control, mold-inhibitor treated samples, mold-inhibitor and green-color-preserved sample of *Neosinocalamus affinis* bamboo. ACQ-D = alkaline copper quaternary type D.

TG-FTIR analysis

Figure 8 shows the thermogravimetric/derivative thermogravimetric (TG/DTG) curves of the surface of the control, the P (treated by Pretreatment III), and the P + A (treated by Pretreatment III + 0.25% ACQ-D) samples of *N. affinis*. From the TG curves, it can be seen that the pyrolysis of the outer surface of *N. affinis* can be divided into three stages. The first pyrolysis stage (below 200°C) was mainly due to the evaporation of water and the low-molecular-weight substances such as extractives. The second pyrolysis stage (200°C to 400°C) showed the most mass loss. This is mainly due to the combustion decomposition of hemicellulose, cellulose, and some lignin (Liu et al. 2013). The last pyrolysis stage at high temperature (400°C to 800°C) was the combustion decomposition of the remaining lignin and

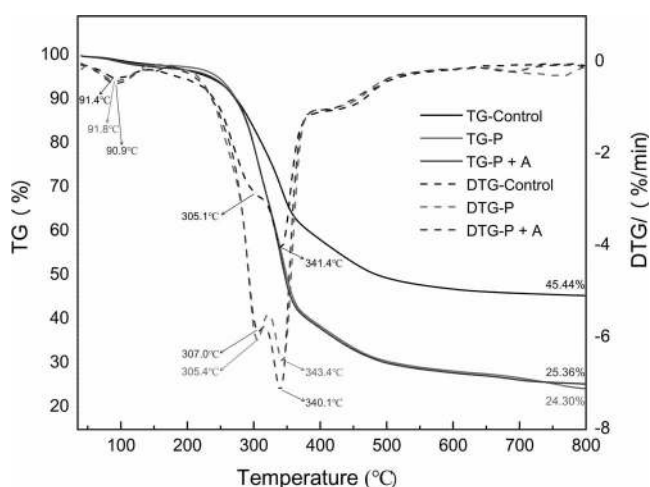

Figure 8.—Thermogravimetric/derivative thermogravimetric (TG/DTG) curves of the green surface of the control, pretreated (P), and treated (P + A) samples of *Neosinocalamus affinis*.

carbon. The TG curves also showed that the residual mass of the untreated bamboo surface was 45.44 percent. For comparison, the obvious difference between the TG curves for the control and the treated samples was the residual mass content; the residual mass content of the P and P + A samples was 24.30 and 25.36 percent, respectively, which was mainly due to the loss of the mineral substances such as silicon during the treatment process. This result was consistent with the silicon determination result as presented above.

As for the DTG curves, the shoulder at around 300°C on the curve for the control became an obvious peak on the curves for the P and P + A samples, which may be because KOH used in the pretreatment process slightly modified the chemical structure of the hemicellulose and cellulose in the outer surface (Chen et al. 2015). The DTG curves also showed that the maximum weight loss rate of the P and P + A samples was higher than that of the control, and the maximum weight loss temperature shifted to a relatively low temperature, indicating that the P and P + A samples were more easily decomposed.

Figure 9 and Table 2 show the infrared absorption spectra at the maximum pyrolysis rate temperatures (341.4°C, 343.4°C and 340.1°C) of the control, P, and P + A samples. The spectra wavelengths were divided into seven regions based on the position of the absorption peak of the main functional group. The stretching vibration of aliphatic $-\text{CH}_2$ and the stretching vibration of $-\text{CH}_3$ of alkanes in the vicinity of $2,935\text{ cm}^{-1}$ are mainly due to the release of CH_4 during pyrolysis (Ma et al. 2015). The pretreatment sample had more obvious peaks, which may be from the β -1,4 glycosidic bonds in hemicellulose and cellulose (Jalbert et al. 2007). The intensity and rich peaks on the pretreatment sample spectrum may be because chemical bond cleavage and hydrolysis occurred during the pretreatment process resulting in more glycoses and sugars retained on the surface of the pretreated bamboo.

The obvious absorption peaks near 2,358, 2,305, and 676 cm^{-1} are mainly derived from the $\text{C}=\text{O}$ stretching vibration of carboxyl and carbonyl, mainly manifested as CO_2 release (Jiang et al. 2012). The $\text{C}-\text{O}$ absorption peaks at 2,182 and

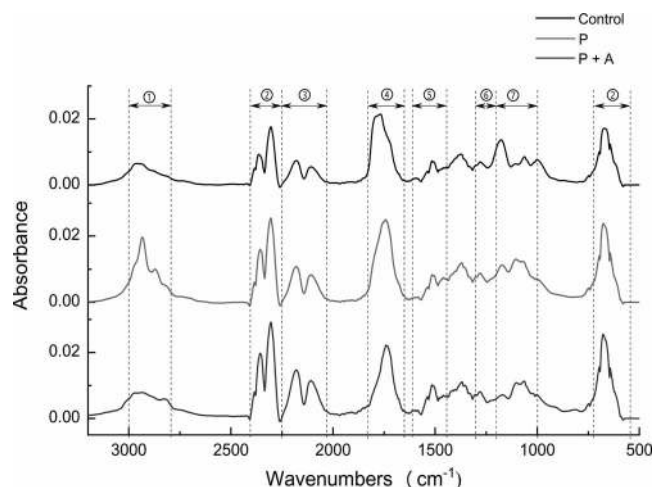

Figure 9.—Infrared spectra from the maximum pyrolysis rate temperatures (341.4°C, 343.4°C and 340.1°C) of the outer surface of *Neosinocalamus affinis* before and after treatment. P = pretreated; P + A = treated.

Table 2.—The typical absorbance peaks and pyrolysis products of *Neosinocalamus affinis*.

No. (from Fig. 9)	Wavelengths (cm ⁻¹)	Functional groups	Vibrations	Components
1	2,935	C–H	Stretching	CH ₄
2	2,358, 2,305, 676	C=O	Stretching, bending	CO ₂
3	2,182, 2,107	C–O	Stretching	CO
4	1,766	C=O	Stretching	Aliphatic aldehydes
5	1,516	C=C, benzene skeleton	Stretching	Aromatics
6	1,278	C–O	Stretching	Phenols
7	1,181, 1,062	Si–O–Si, C–O	Stretching	SiO ₂ , alcohols

2,107 cm⁻¹ are C=O stretching vibrations of some aldehydes, ketones, and acids (Chen et al. 2015). There was a slight deviation in the absorption peak at 1,766 cm⁻¹ corresponding to the stretching vibrations of aliphatic aldehydes between the control and the treated samples. The C=C skeleton stretching vibration of the benzene ring occurs at 1,516 cm⁻¹ (Ma et al. 2017). The characteristic absorption peak at 1,278 cm⁻¹ was attributed to the phenols and alcohols. The absorption band at 1,181 cm⁻¹, which was ascribed from the asymmetrical stretching vibration of Si–O–Si in SiO₂ (Smith 1960), was relatively intense in the spectrum of the control; the intensity decreased and the peak became broader in the spectra of the pretreated and ACQ-D-treated samples. The changes in the absorption band at 1,181 cm⁻¹ indicated the removal of silicon during the pretreatment process, which was consistent with the silicon determination results and the DTG pyrolysis profile.

The TG-FTIR analysis results of the samples before and after the treatment revealed that the treatment using ACQ-D solution slightly modified the chemical structure, i.e., chemical compounds on the surface of *N. affinis* bamboo may undergo molecular chain breakage and hydrolysis during the pretreatment and treatment with ACQ-D. Meanwhile, the near removal of the SiO₂ was indicated in the TG-FTIR analysis.

Conclusions

The process optimization results showed that for color preservation the optimal process was pretreatment with 0.7 percent KOH and 0.7 percent SDS and treatment with 0.25 percent ACQ-D solution at 100°C for 2 hours. The mold resistance results revealed that samples treated by the color preservation process could prevent the growth of *T. harzianum*. The color durability test indicated that the ACQ-D-treated *N. affinis* bamboo has great potential for high-UV-exposure interior applications. TG-FTIR spectra indicated slight changes in surface chemical structure and the removal of silicon. The results of this research showed that dilute ACQ-D could retain the green color of *N. affinis* bamboo and improve the mold resistance by altering the surface chemistry. Possible reactions between the solutions and the bamboo compounds during the treatment should be further evaluated.

Acknowledgments

This work has been supported by the Key Laboratory of Wood Industry and Furniture Engineering of Sichuan Provincial Colleges and Universities.

Literature Cited

ASTM International. 2015. Standard test method for fungicides for controlling sapstain and mold on unseasoned lumber (laboratory

- method). ASTM D4445-10 (Reapproved 2015). ASTM International, West Conshohocken, Pennsylvania.
- Cattaneo, T. M. P., C. Giardina, N. Sinelli, M. Riva, and R. Giangiaco. 2005. Application of FT-NIR and FT-IR spectroscopy to study the shelf-life of Crescenza cheese. *Int. Dairy J.* 15(6–9):700.
- Chang, S. 2000. Green-color conservation of ma bamboo (*Dendrocalamus latiflorus*) treated with chromium-based reagents. *J. Wood Sci.* 46(1):40–44.
- Chang, S. and J. Wu. 2000. Stabilizing effect of chromated salt treatment on the green color of ma bamboo (*Dendrocalamus latiflorus*). *Holzforchung* 54(3):327–330.
- Chang, S., J. Wu, and T. Yeh. 2002a. Effects of chromated-phosphate treatment process on the green color protection of ma bamboo (*Dendrocalamus latiflorus*). *J. Wood Sci.* 48(3):227–231.
- Chang, S. and T. Yeh. 2001. Protection and fastness of green color of moso bamboo (*Phyllostachys pubescens* Mazel) treated with chromium-based reagents. *J. Wood Sci.* 47(3):228–232.
- Chang, S., T. Yeh, J. Wu, and D. N. S. Hon. 2002b. Reaction characteristics on the green surface of moso bamboo (*Phyllostachys pubescens* Mazel) treated with chromated phosphate. *Holzforchung* 56(2):130–134.
- Chele, E., R. Moreno-Cuesta, A. Portales, and T. Magal-Royo. 2012. Bamboo, from traditional crafts to contemporary design and architecture. *Procedia Soc. Behav. Sci.* 51:777–781.
- Chen, D., D. Liu, H. Zhang, Y. Chen, and Q. Li. 2015. Bamboo pyrolysis using TG-FTIR and a lab-scale reactor: Analysis of pyrolysis behavior, product properties, and carbon and energy yields. *Fuel* 148:79–86.
- Chen, L., L. He, J. Xie, Z. Qiu, J. Qi, Y. Jiang, H. Xiao, Y. Chen, C. F. De Hoop, and C. Hse. 2019. The effect of chemical treatment on green color preservation and surface characteristics of *Neosinocalamus affinis* bamboo. *BioResources* 14(3):5327–5338.
- Chung, M. J., S. Cheng, and S. Chang. 2008. Environmental-benign methods for the color protection of stripe long-shoot bamboo (*Bambusa dolichoclada*) culms. *Buuld. Environ.* 43(5):745–750.
- Chung, M. J., S. Cheng, and S. Chang. 2009. Environmentally benign methods for producing green culms of ma bamboo (*Dendrocalamus latiflorus*) and moso bamboo (*Phyllostachys pubescens*). *J. Wood Sci.* 55(3):197–202.
- Chung, M. J., J. Wu, and S. Chang. 2005. Green colour protection of makino bamboo (*Phyllostachys makinoi*) treated with ammoniacal copper quaternary and copper azole preservatives. *Polym. Degrad. Stability* 90(1):167–172.
- Jalbert, J., R. Gilbert, P. Tétreault, B. Morin, and D. Lessard-Déziel. 2007. Identification of a chemical indicator of the rupture of 1,4-β-glycosidic bonds of cellulose in an oil-impregnated insulating paper system. *Cellulose* 14(4):295–309.
- Jiang, Z., Z. Liu, B. Fei, Z. Cai, Y. Yu, and X. E. Liu. 2012. The pyrolysis characteristics of moso bamboo. *J. Anal. Appl. Pyrolysis* 94:48–52.
- Liu, Z., B. Fei, Z. Jiang, Z. Cai, Y. Yu, and X. E. Liu. 2013. A comparative study of thermal properties of sinocalamus affinis and moso bamboo. *J. Therm. Anal. Calorimet.* 111(1):393–399.
- Ma, Z., Q. Sun, J. Ye, Q. Yao, and Z. Chao. 2015. Study on the thermal degradation behaviors and kinetics of alkali lignin for production of phenolic-rich bio-oil using TGA-FTIR and Py-GC/MS. *J. Anal. Appl. Pyrolysis* 117:116–124.
- Ma, Z., Y. Yang, Q. Ma, H. Zhou, X. Luo, X. Liu, and S. Wang. 2017. Evolution of the chemical composition, functional group, pore

- structure and crystallographic structure of bio-char from palm kernel shell pyrolysis under different temperatures. *J. Anal. Appl. Pyrolysis* 127:350–359.
- Oyedun, A. O., T. Gebreegziabher, and C. W. Hui. 2013. Mechanism and modelling of bamboo pyrolysis. *Fuel Process. Technol.* 106:595–604.
- Scurlock, J. M. O. 2000. Bamboo: An over-looked biomass resource? *Biomass Bioenergy* 19(4):229–244.
- Smith, A. L. 1960. Infrared spectra-structure correlations for organo-silicon compounds. *Spectrochim. Acta* 16(1–2):87–105.
- Wang, X. and H. Ren. 2008. Comparative study of the photo-discoloration of moso bamboo (*Phyllostachys pubescens* Mazel) and two wood species. *Appl. Surface Sci.* 254(21):7029–7034.
- Wang, Y. J., C. D. Huang, X. S. Wang, H. U. Tao, and G. Q. Zhang. 2009. Carbon stock and spatial distribution characteristics of *Neosinocalamus affinis* forest ecosystem. *J. Fujian Forestry Sci. Technol.* 36(02):6–9, 87.
- Wenhua, L. 2006. Research on wood, bamboo and rattan cane discoloration. *World Forestry Res.* 2006(04):38–44.
- Wu, J. H., M. Chung, and S. Chang. 2004. Evaluation of the effectiveness of alcohol-borne reagents on the green colour protection of makino bamboo (*Phyllostachys makinoi*). *Polym. Degrad. Stability* 83(3):473–479.
- Wu, J. H., S. Y. Wu, and T. Y. Hsieh. 2002. Effects of copper-phosphorous salt treatments on green color protection and fastness of ma bamboo (*Dendrocalamus latiflorus*). *Polym. Degrad. Stability* 78(2):379–384.
- Xu, G., L. Wang, J. Liu, and S. Hu. 2013. Decay resistance and thermal stability of bamboo preservatives prepared using camphor leaf extract. *Int. Biodeter. Biodegrad.* 78:103–107.
- Zhang, Y., W. Yu, and Y. Zhang. 2013. Effect of steam heating on the color and chemical properties of *Neosinocalamus affinis* bamboo. *J. Wood Chem. Technol.* 33(4):235–246.